













Dati Tecnici - Specifications

											
	cond	comp.W	ABS.W	Fuse	Kwh/100Kg	I/h	kg	Lbs	kg	Lbs	Ton CO2 equiv.
E90 A		1593	790	10	17.9	9.71	68	150	76	167	0.72
E90 W		1593	460	10	14.3	52.2	68	150	76	167	0.72



Produzione Ghiaccio - Ice Production

Raffreddamento ad aria - Air Cooled Unit

Temp.Aria Air Temp. °C	Temp.Acqua Water Temp.			
	32°	21°	15°	10°
°F	90°	70°	60°	50°
10°	77	85	89	92
50°	170	187	196	203
21°	72	78	82	84
70°	159	172	181	185
32°	63	68	71	73
90°	139	150	157	161
38°	51	55	57	59
100°	112	121	126	130

Raffreddamento ad acqua - Water Cooled Unit

Temp.Aria Air Temp. °C	Temp.Acqua Water Temp.			
	32°	21°	15°	10°
°F	90°	70°	60°	50°
10°	77	84	87	90
50°	170	185	191	198
21°	71	77	81	84
70°	156	169	178	185
32°	70	76	79	82
90°	154	167	174	180
38°	66	71	74	76
100°	145	156	163	167



PANNELLO DI CONTROLLO - CONTROL PANEL

Rosso: Allarmi Red: Alarm State Verde: Stato Macchina Green: Machine state



Interruttore On/Off Swich On/Off

Pulsante Reset Reset Button

CAPACITÀ DEPOSITO - BIN CAPACITY

40 Kg - 88 lbs
2352 pcs

DIMENSIONI - DIMENSIONS

LxPxH (mm)
800 x 585 x 956

WxDxH (inch)
31 8/16" x 23 1/16" x 37 10/16"

TIPO GHIACCIO - ICE TYPE

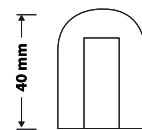

17g

PESO GHIACCIO
WEIGHT ICE

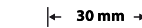





60

PZ/CICLO
PCS/CYCLE

CONDIZIONI USO-OPERATING REQUIREMENTS



220-240V / 1 / 50Hz R134a GWP=1430

MIN		MAX
10°C (50°F)		40°C (104°F)
5°C (41°F)		35°C (95°F)
- 10 %		+ 10 %
1 BAR (14 PSI)		5 BAR (70 PSI)

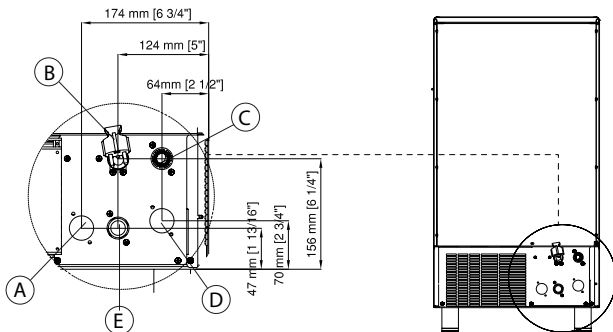
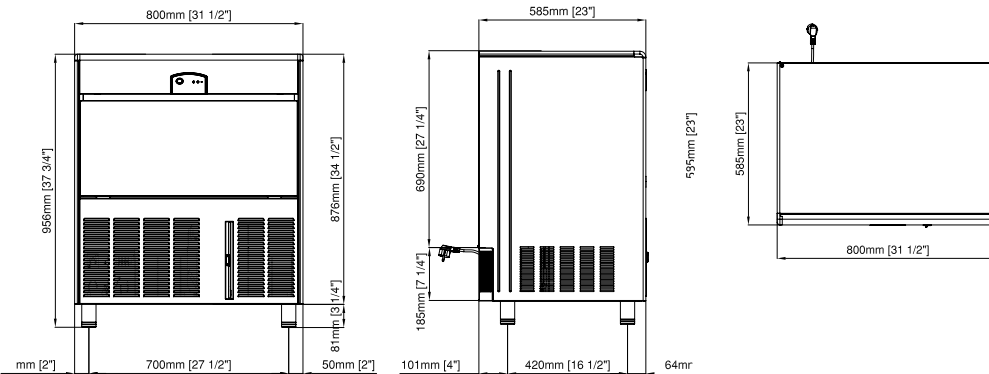

- (A)** OPTIONAL: Entrata acqua per macchine condensate ad acqua - 3/4" gas
OPTIONAL: Water cooled units inlet - 3/4" gas
- (B)** Ingresso alimentazione elettrica
Electrical cable supply
- (C)** Attacco scarico acqua Ø 20 mm
Water outlet connection Ø 20 mm
- (D)** Uscita acqua per macchine condensate ad acqua - Ø 20 mm
Water cooled units Outlet - Ø 20 mm
- (E)** Attacco entrata acqua - 3/4" gas
Water inlet connection - 3/4" gas

E90 230V/1N/50Hz Self contain - Paddle System